

# Data Sheet



Article number: 604144056030

Description: Timing belt pulley with hub  
HTD 56 8M 30

## Measures

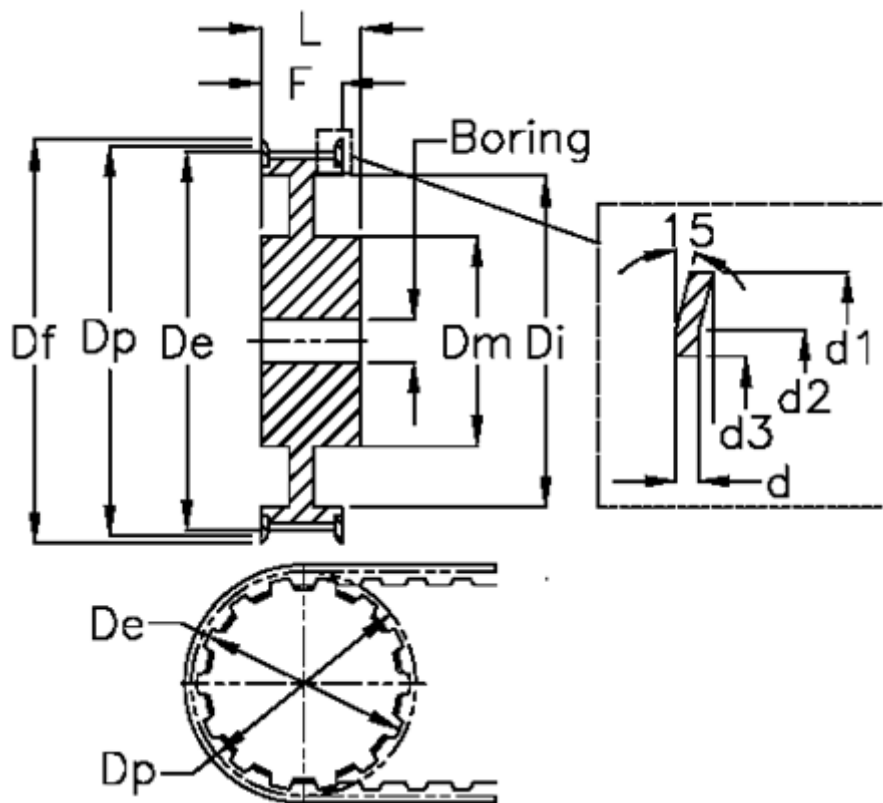

Bore = 15	Dm = 90	Width = 30
d = 1.5	Dp = 142.6	
d1 = 150	F = 116	
d2 = 145	Flange type = F48	
d3 = 130	L = 38	
De = 141.23	Tooth number = 56	
Df = 150	Type = 8M	
Di = 48	Weight = 3.6	